

150 Bed

Assembly Instructions

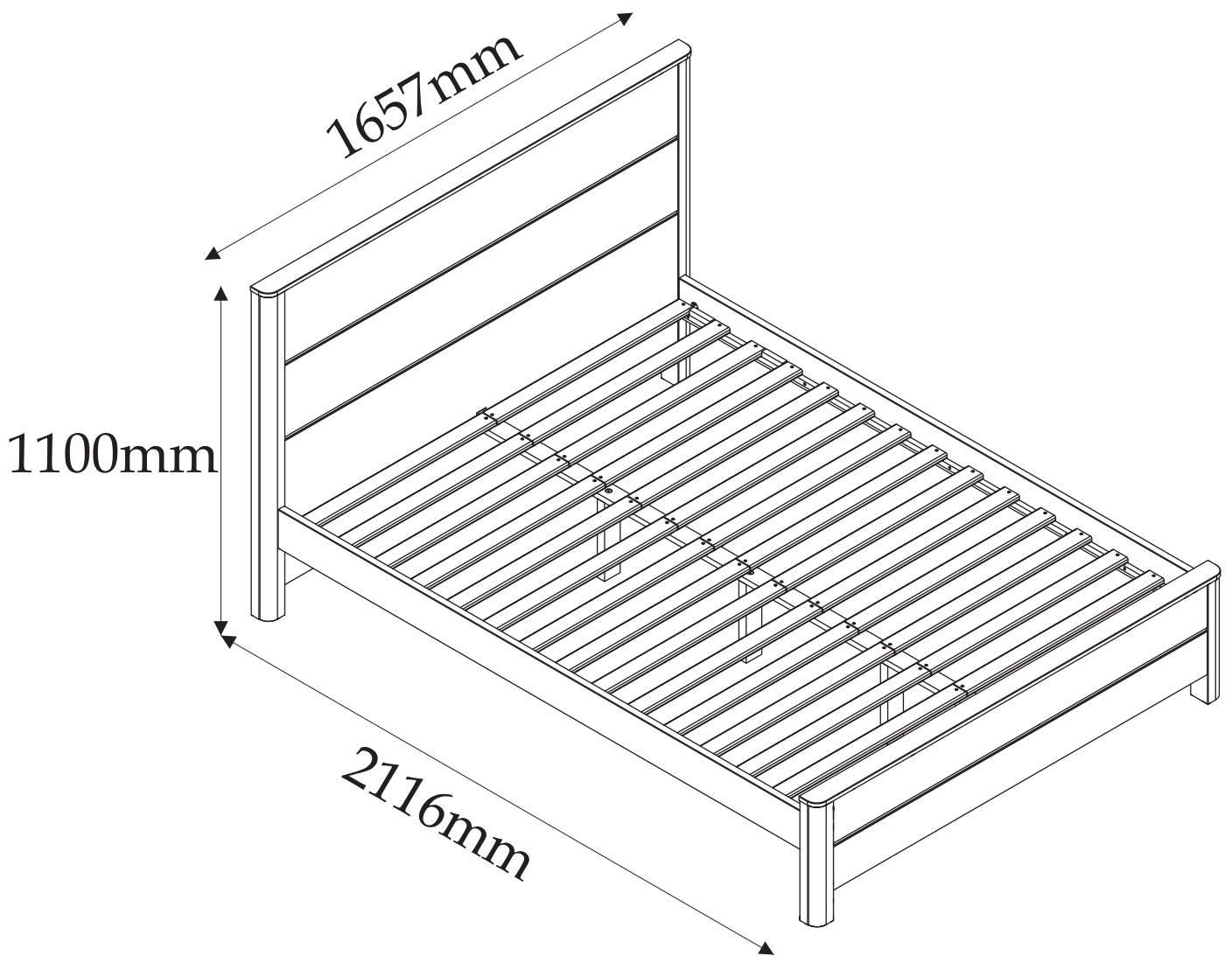

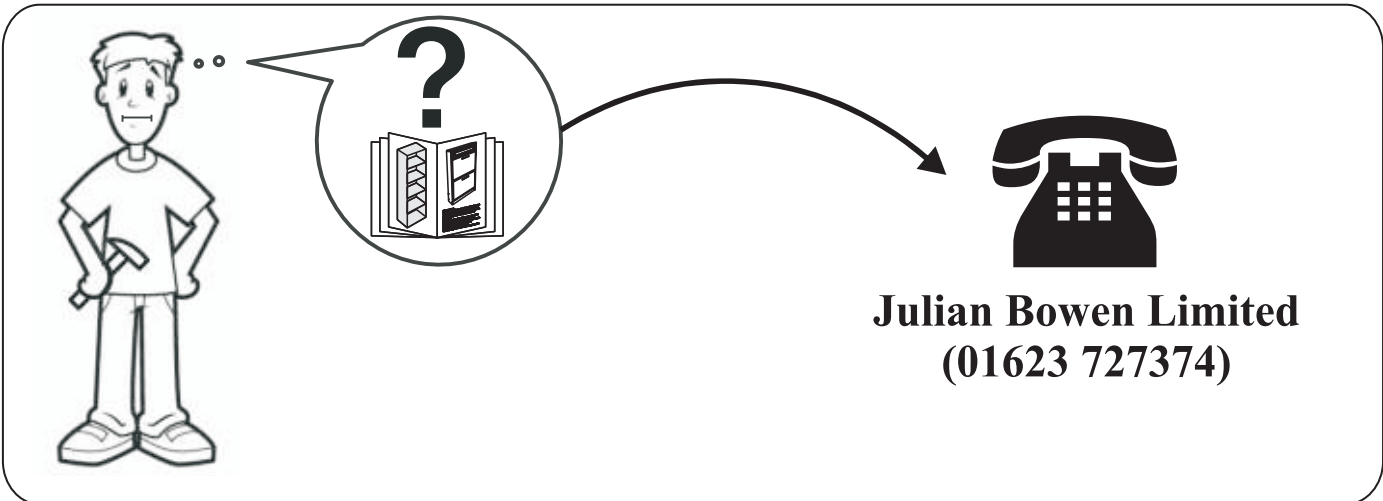
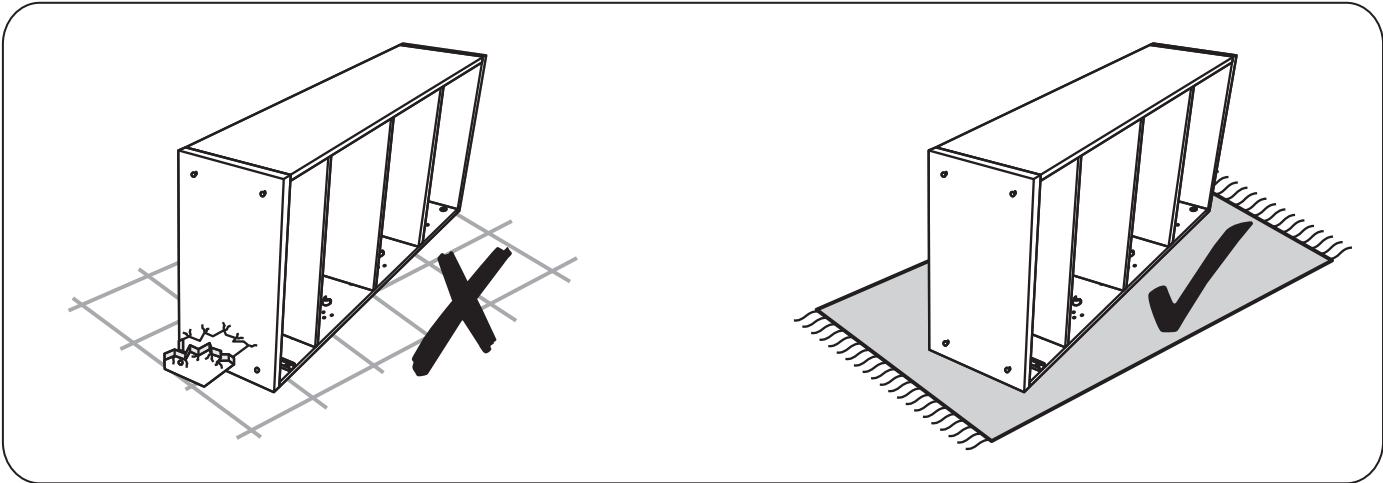
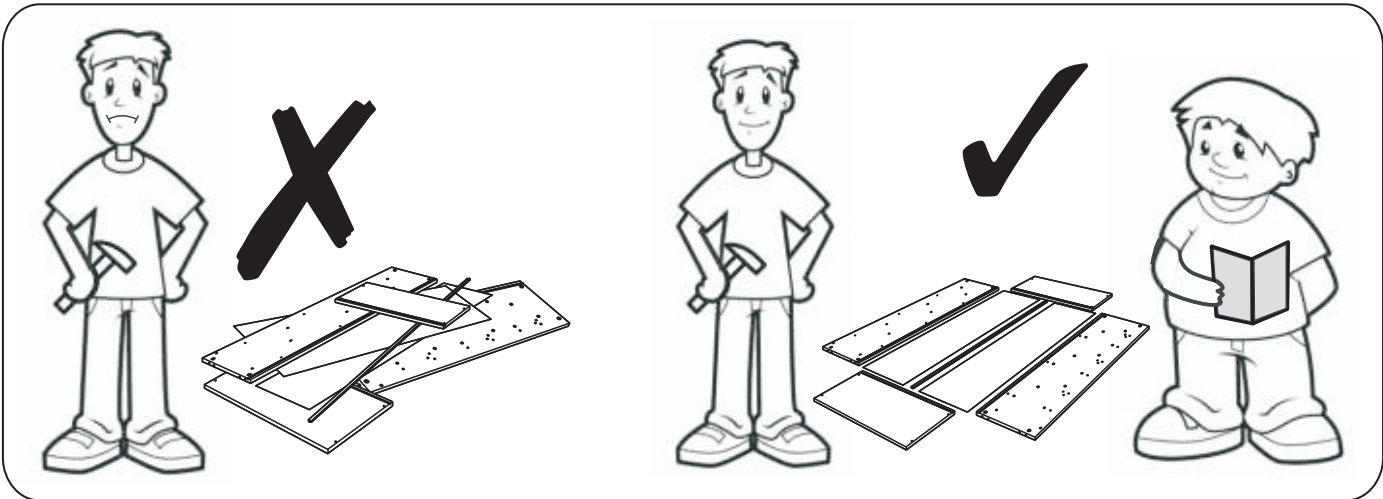
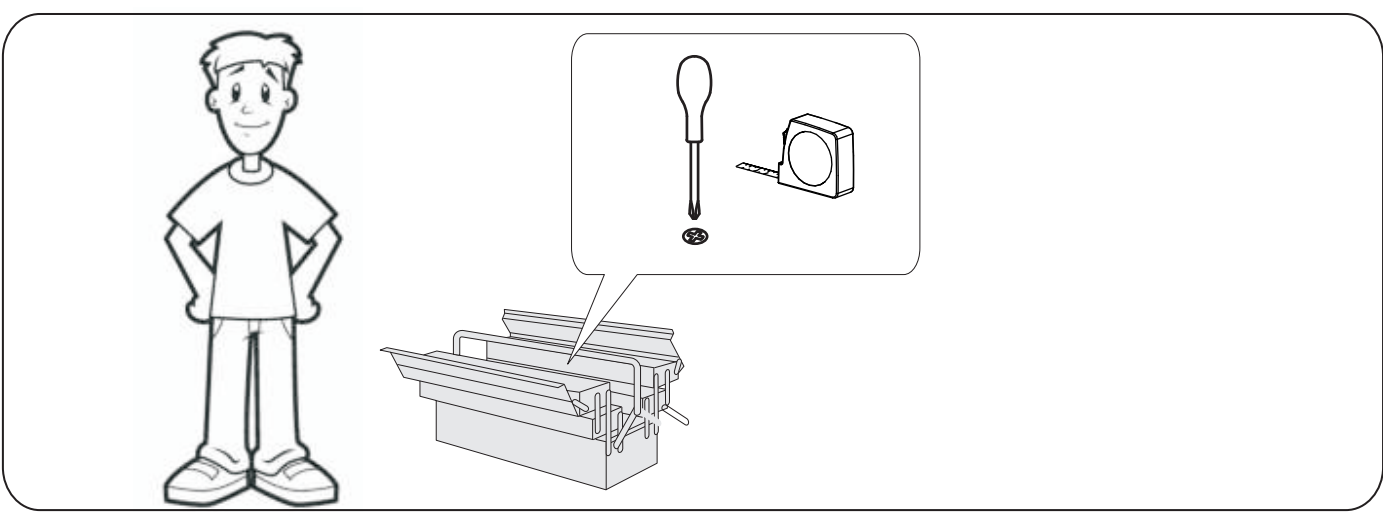

Julian Bowen Limited
(01623 727374)

HARDWARE



A
3,5x16mm
8x



B
15x11mm
26x



C
6,5x35mm
26x

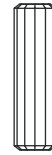

D
8x30mm
26x



E
4x35mm
60x

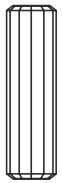

F
10x50mm
8x



G
1/4x90mm
2x



H
Ø18mm
12x



I
7x40mm
3x



J
2x



K
1/4x67mm
2x



L
2x

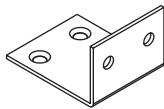

M
2x



N
4x40mm
1x



O
1x

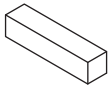

P
77x18mm
2x

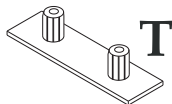

T
4x

PARTS

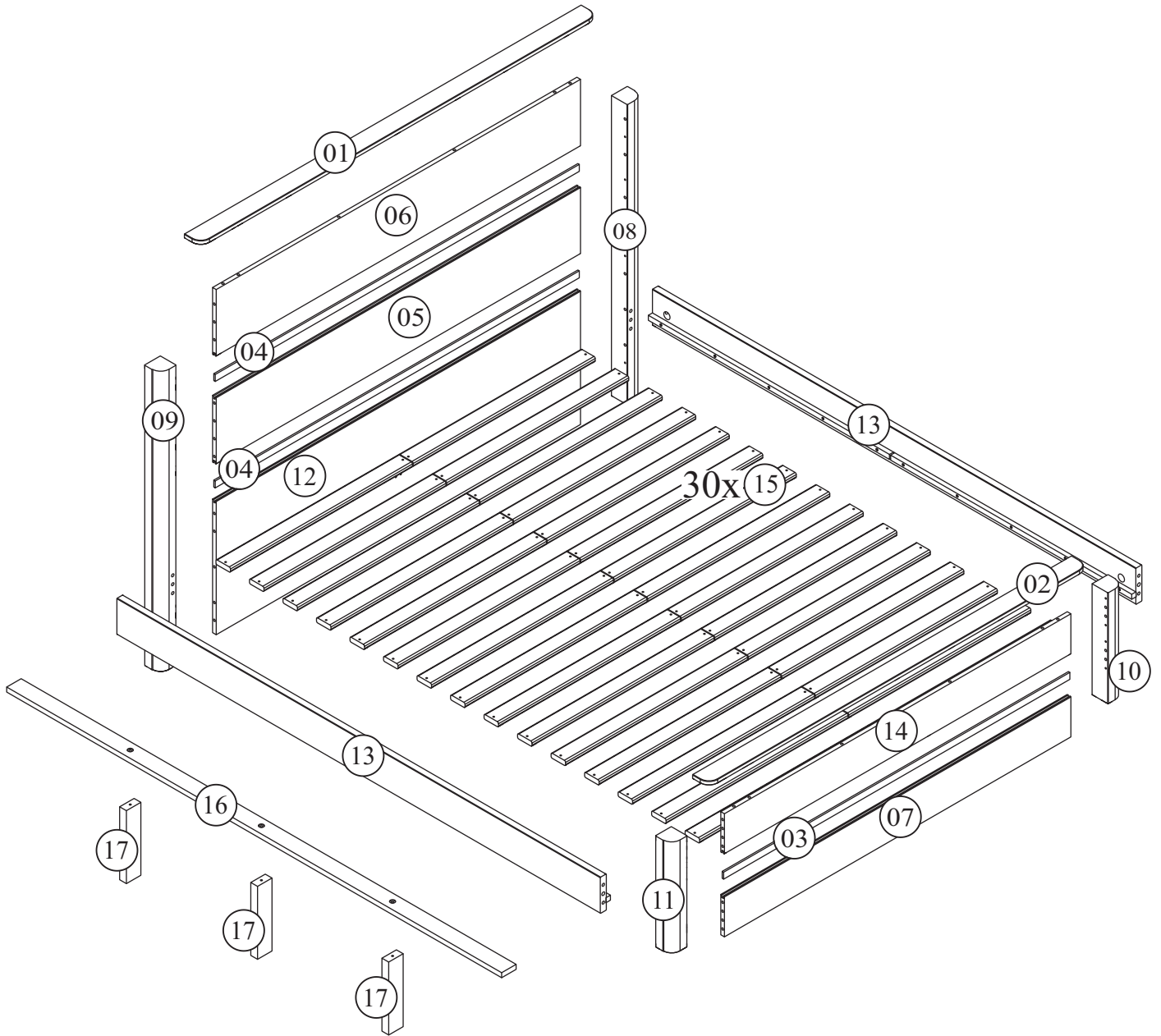

Safety Advice

Please take the time to carefully read through the whole of these instructions before you commence. Keep these instructions for future reference. Unpack, inspect and check off all of the contents. Please dispose of all packaging safely. Small component parts could choke a child if swallowed. We strongly recommend that you keep children well away from the work area. It would be sensible to lay a sheet or blanket on the floor where you intend to work to avoid scratching this product and to protect your floor. This product is heavy. Take extreme care when lifting to avoid personal injury or damage to the product. Assemble the product as close to its intended final position in the room as possible.

HANDY HINT: If you keep the hardware in a bowl during assembly you will be less likely to lose them.

We strongly urge that you do not use Power Tools, such as drills or electric screwdrivers during this assembly as this could cause irreparable damage to your product and will invalidate the warranty.

“WARNING: In order to prevent overturning this product must be used with the wall attachment device provided.”

1

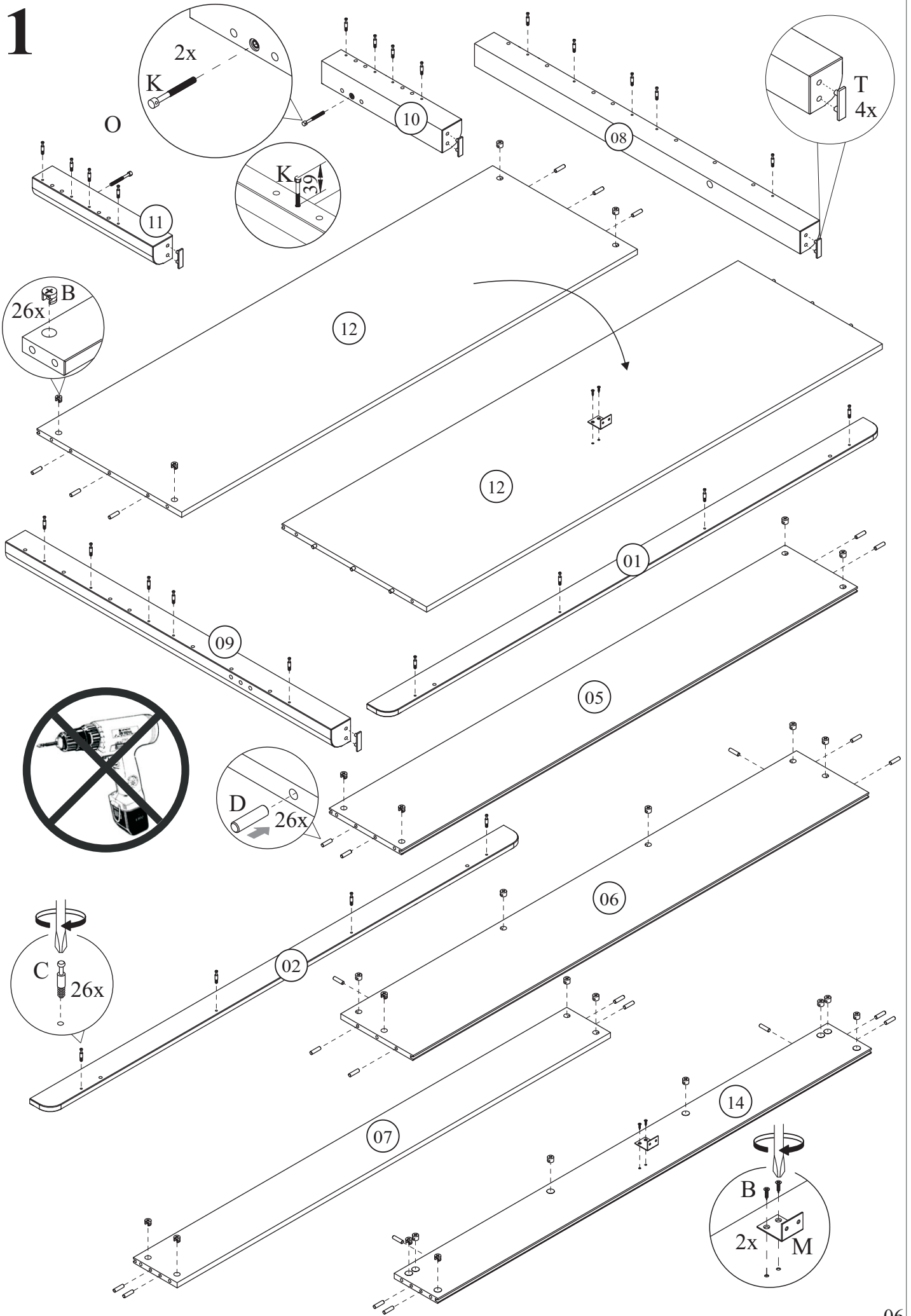

2

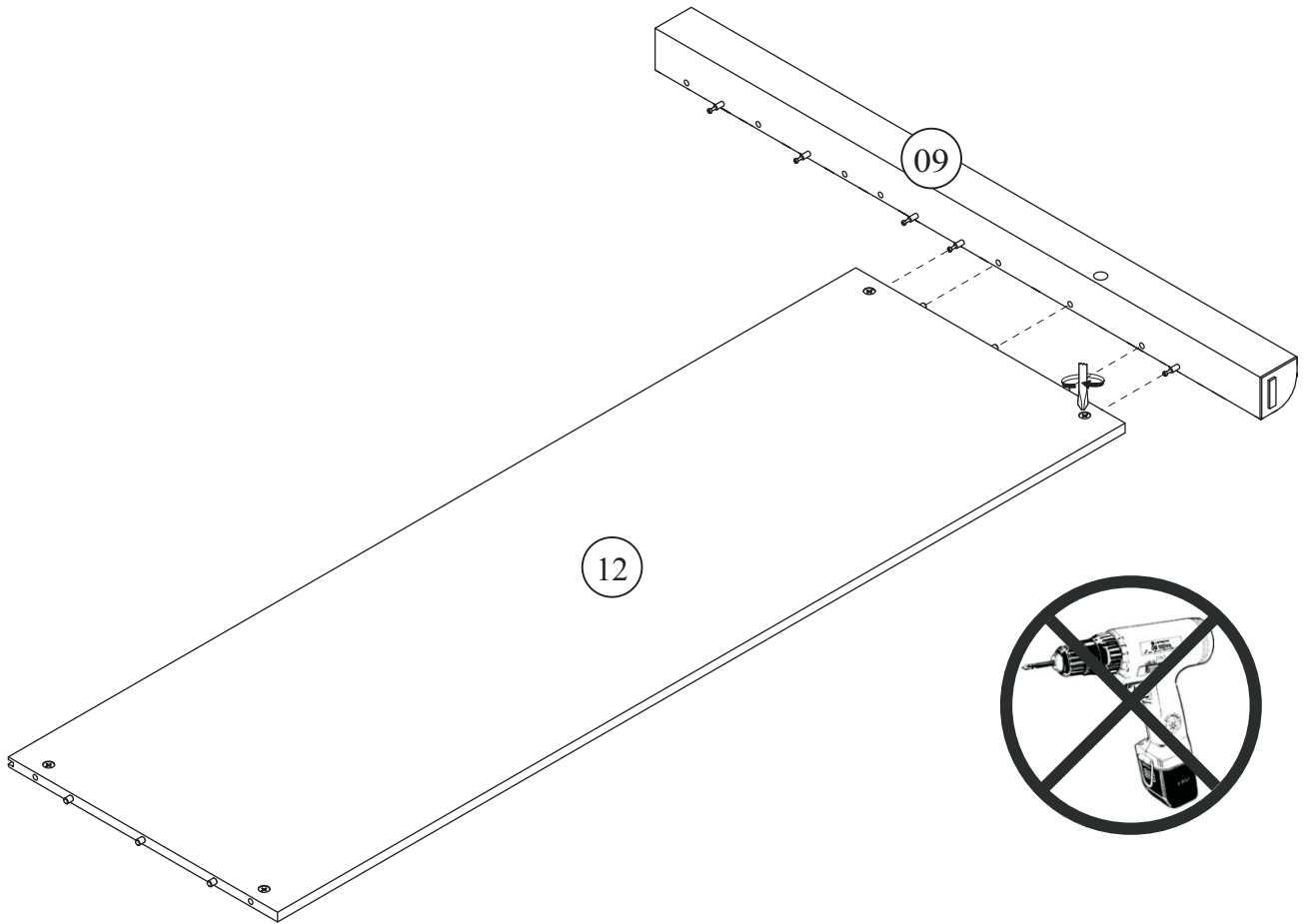

3

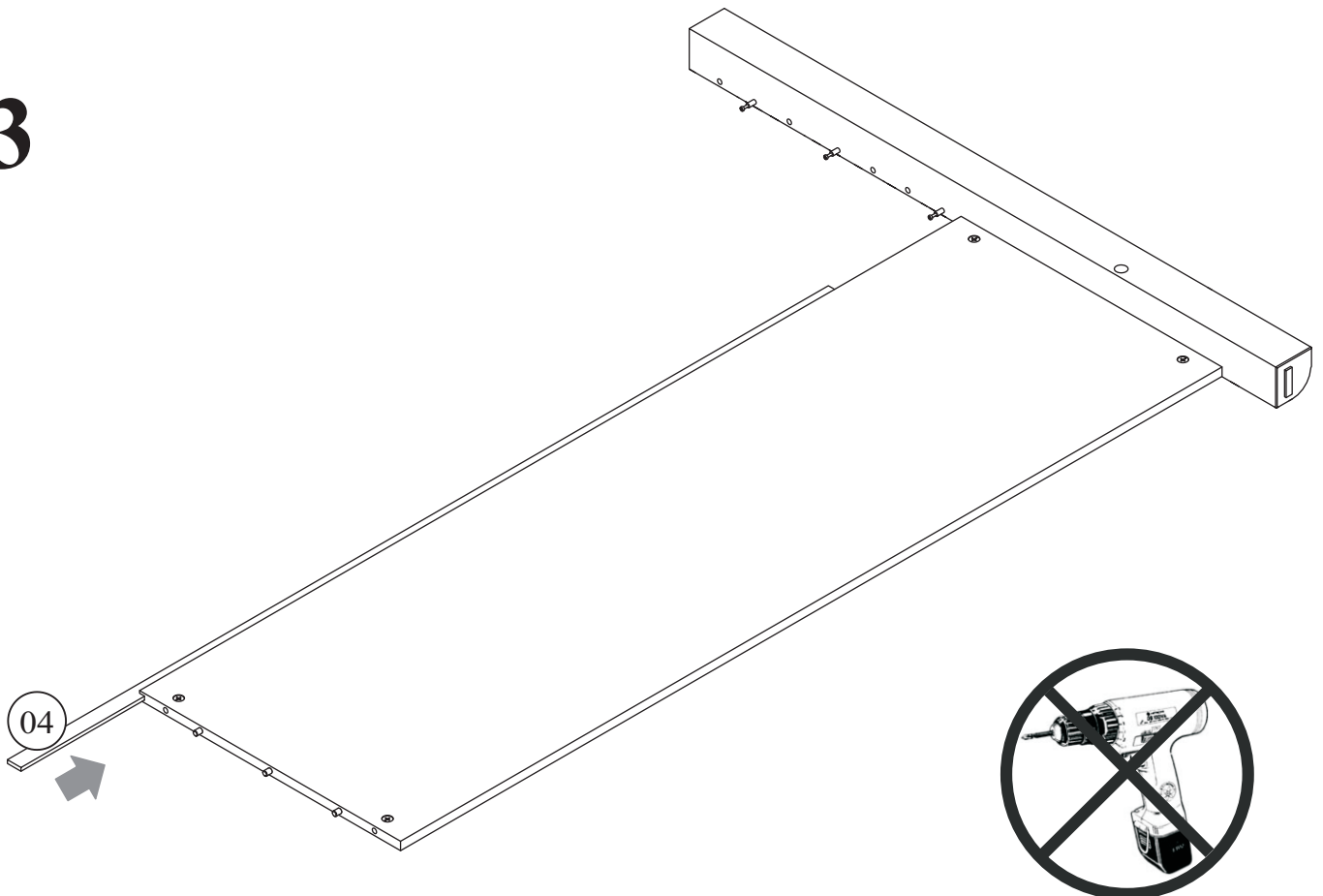

4

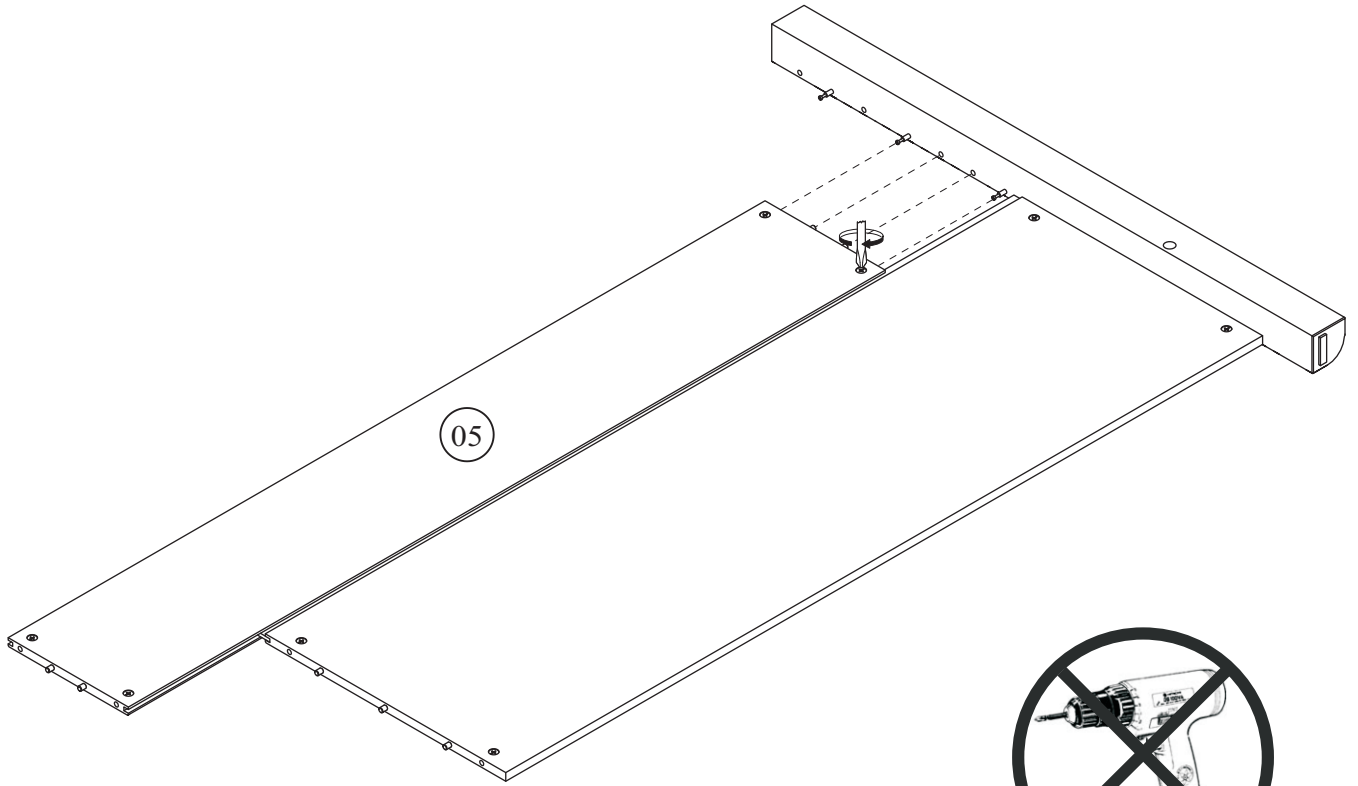

05



5

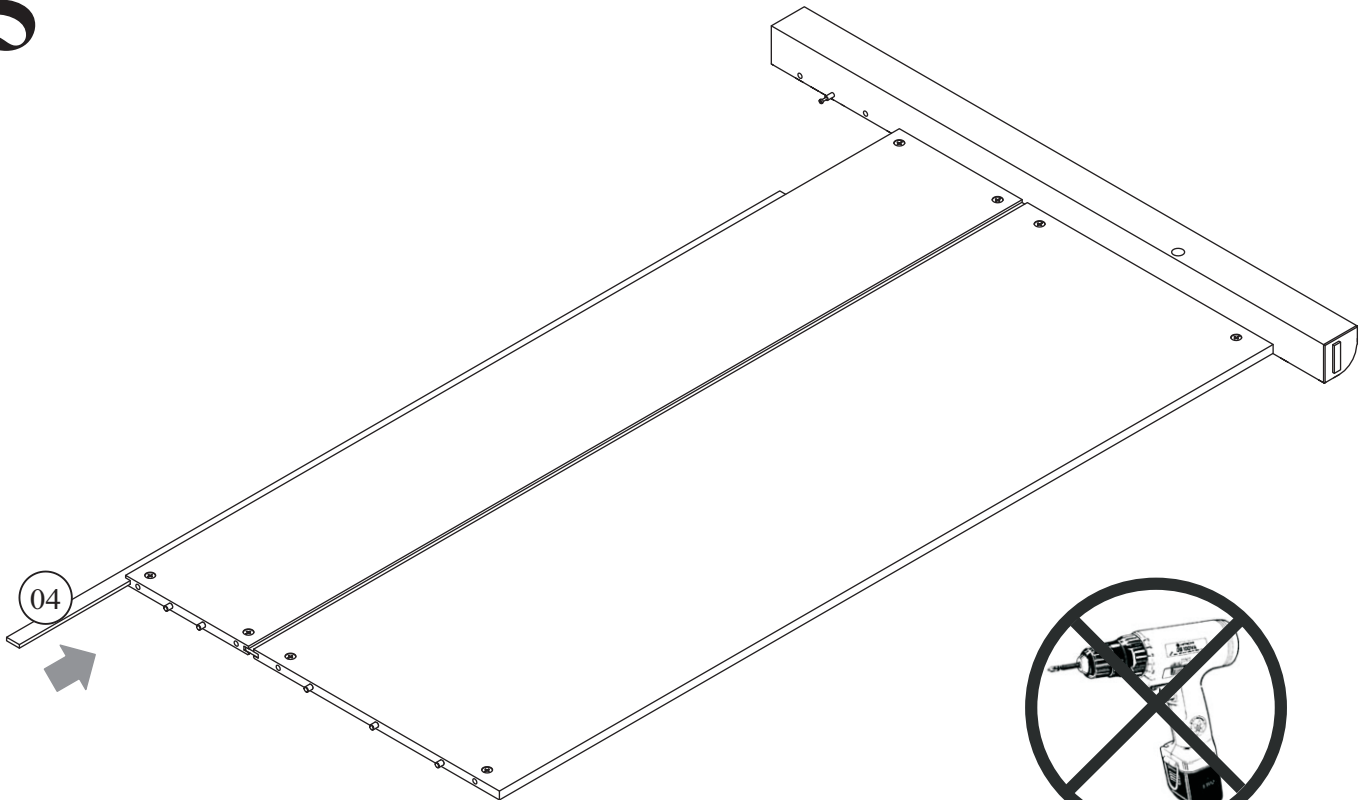

04

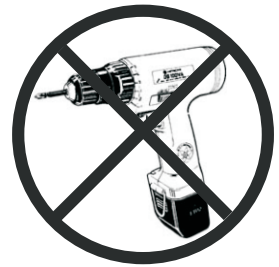

6

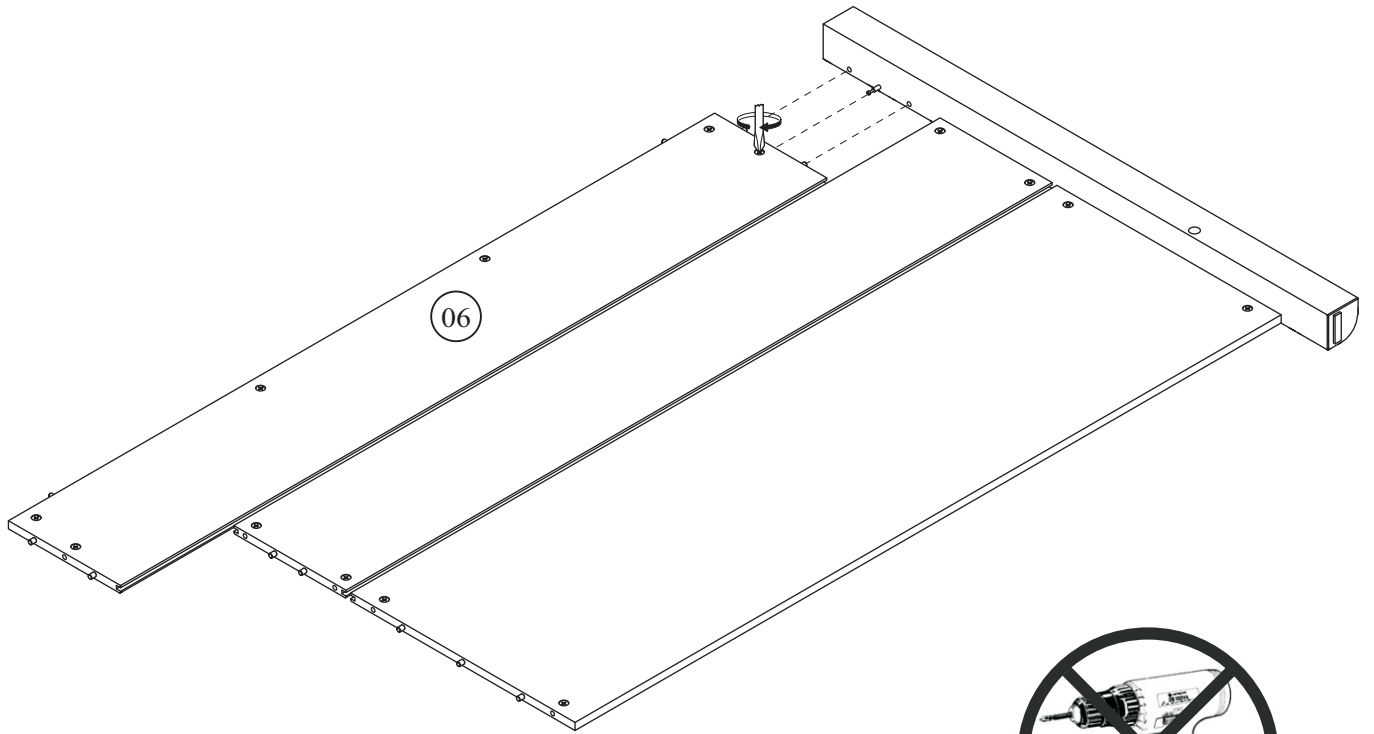

7

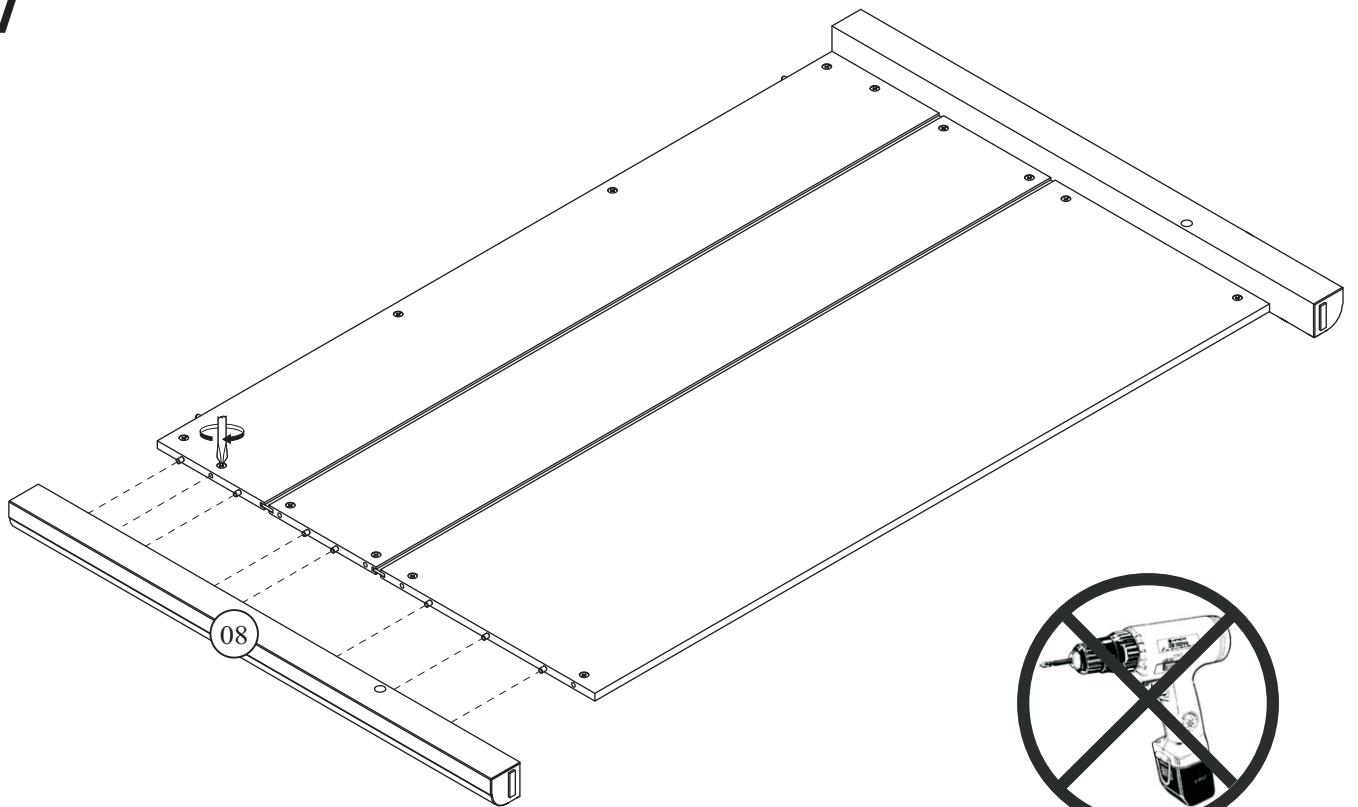

8

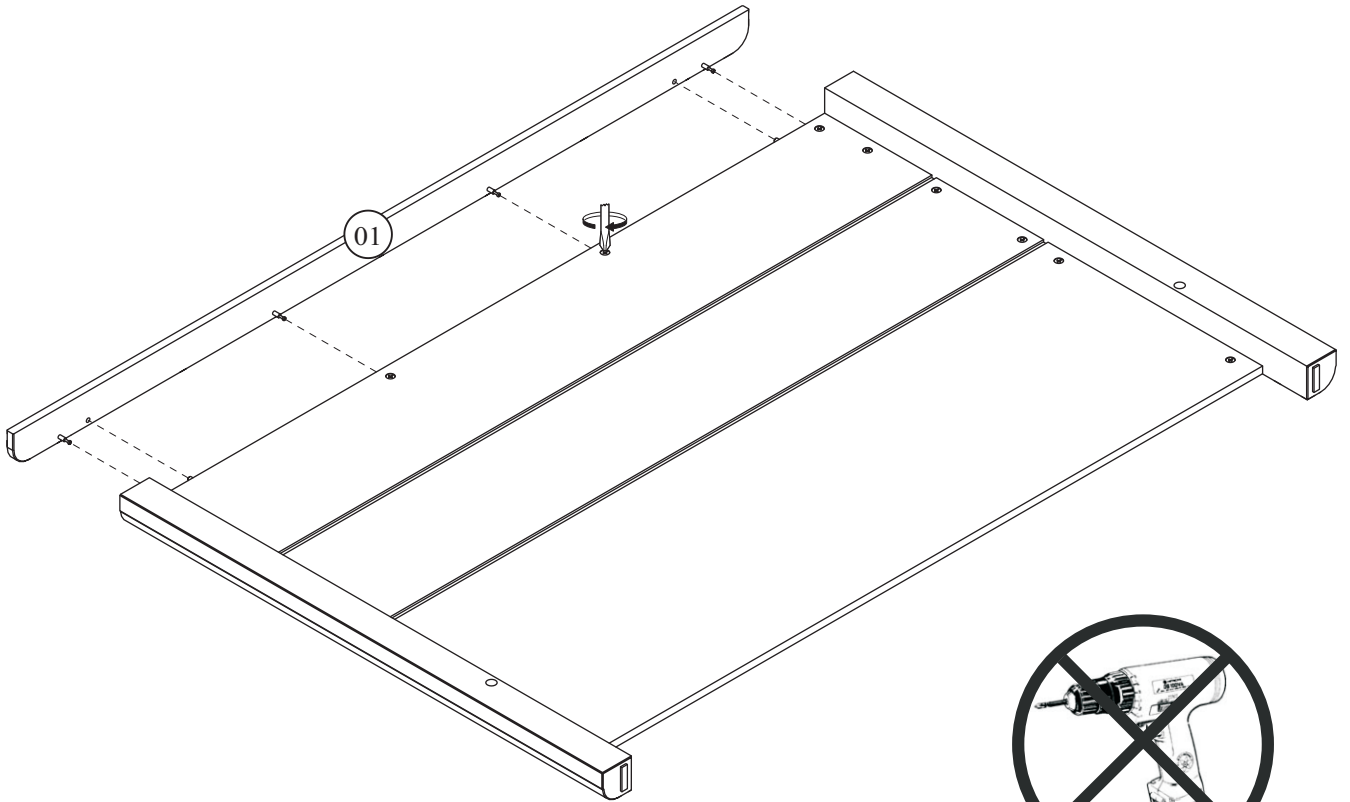

9

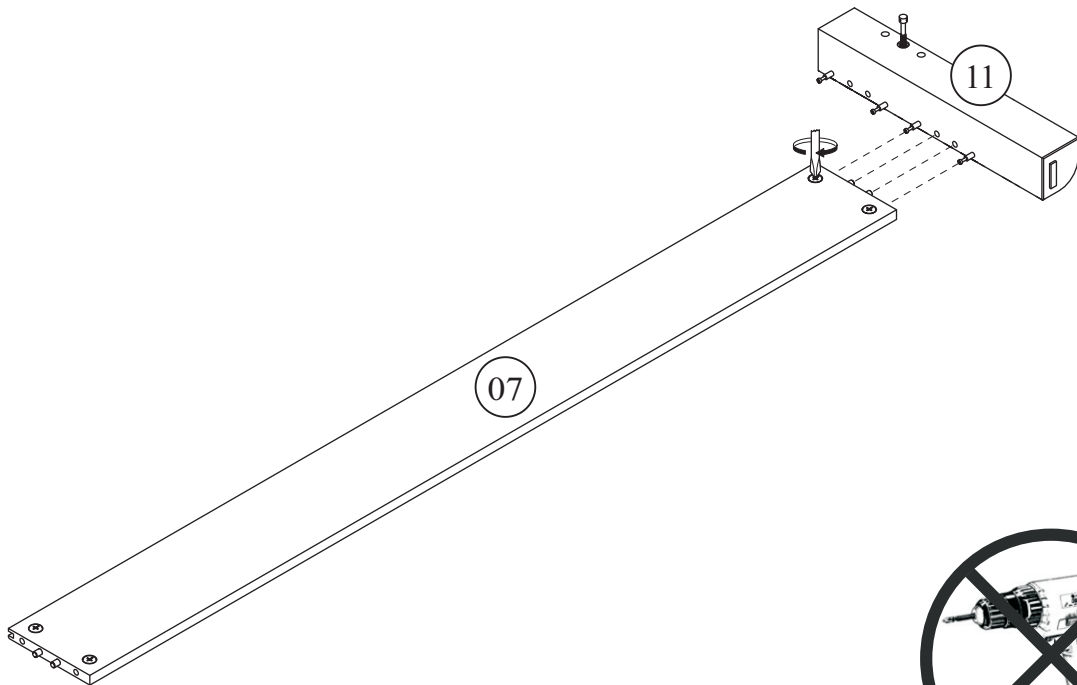

10

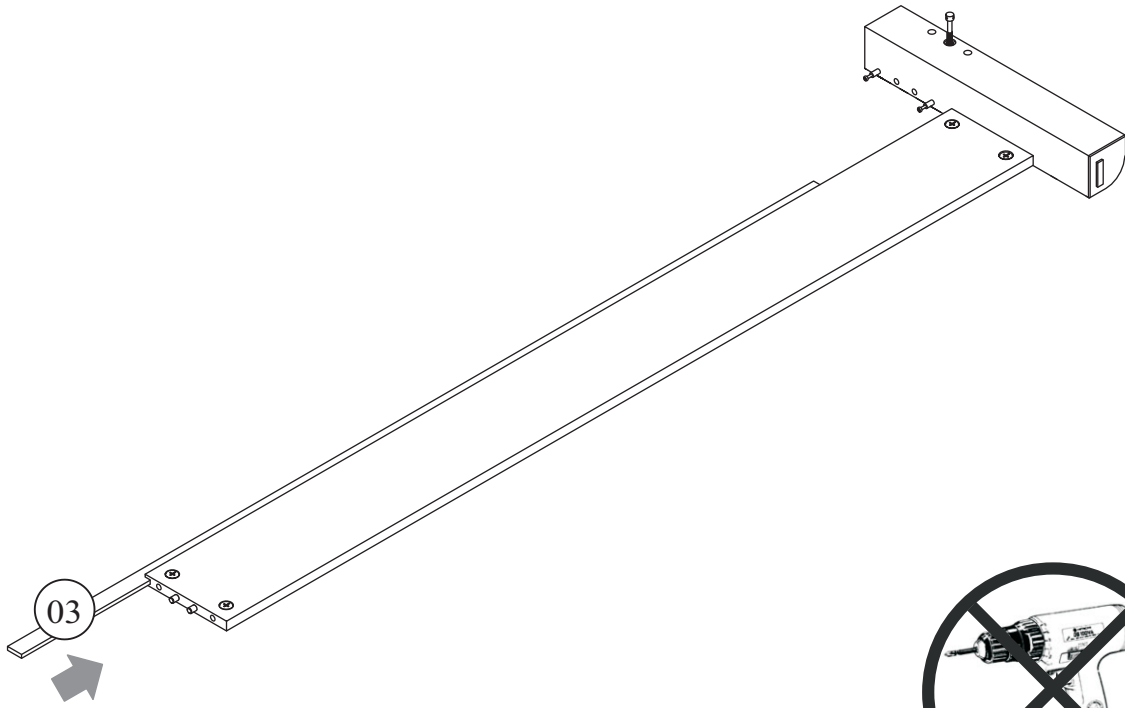

11

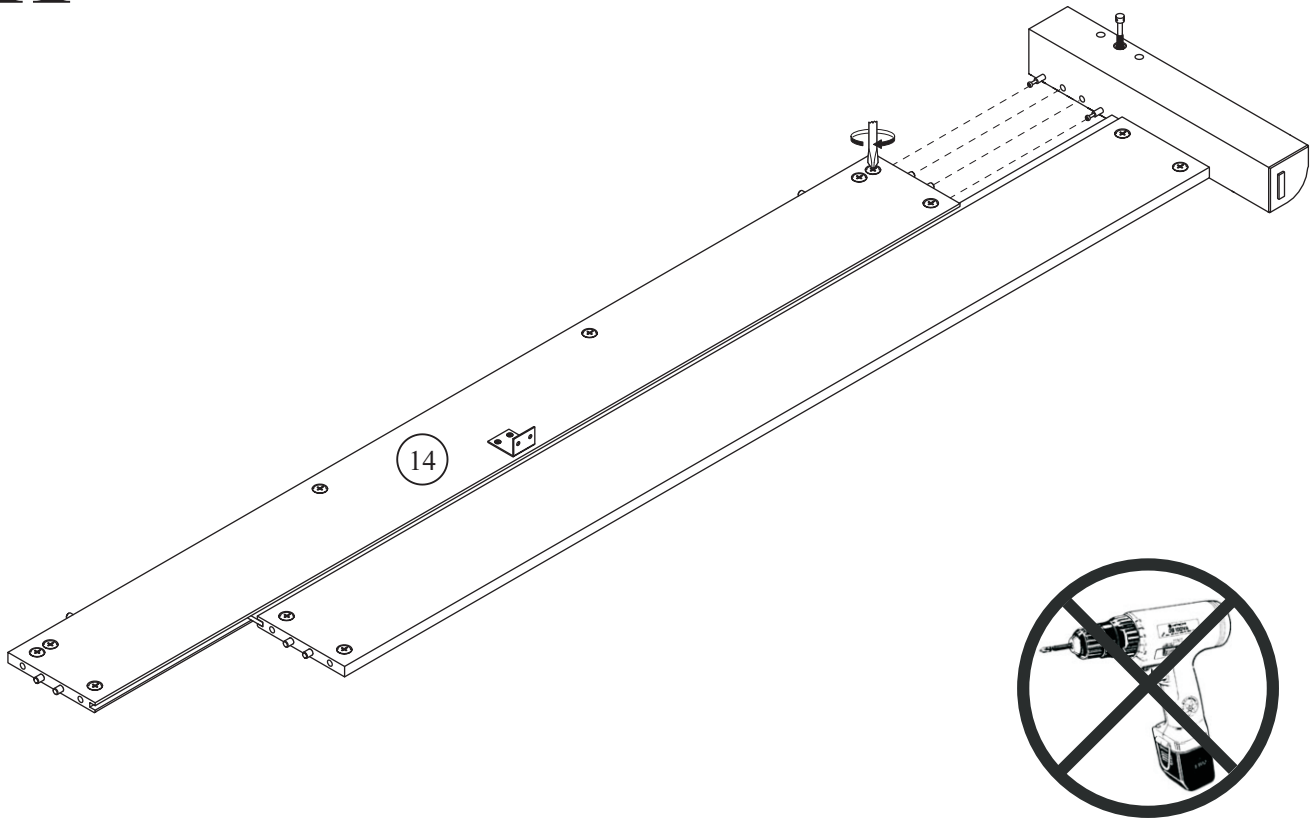

12

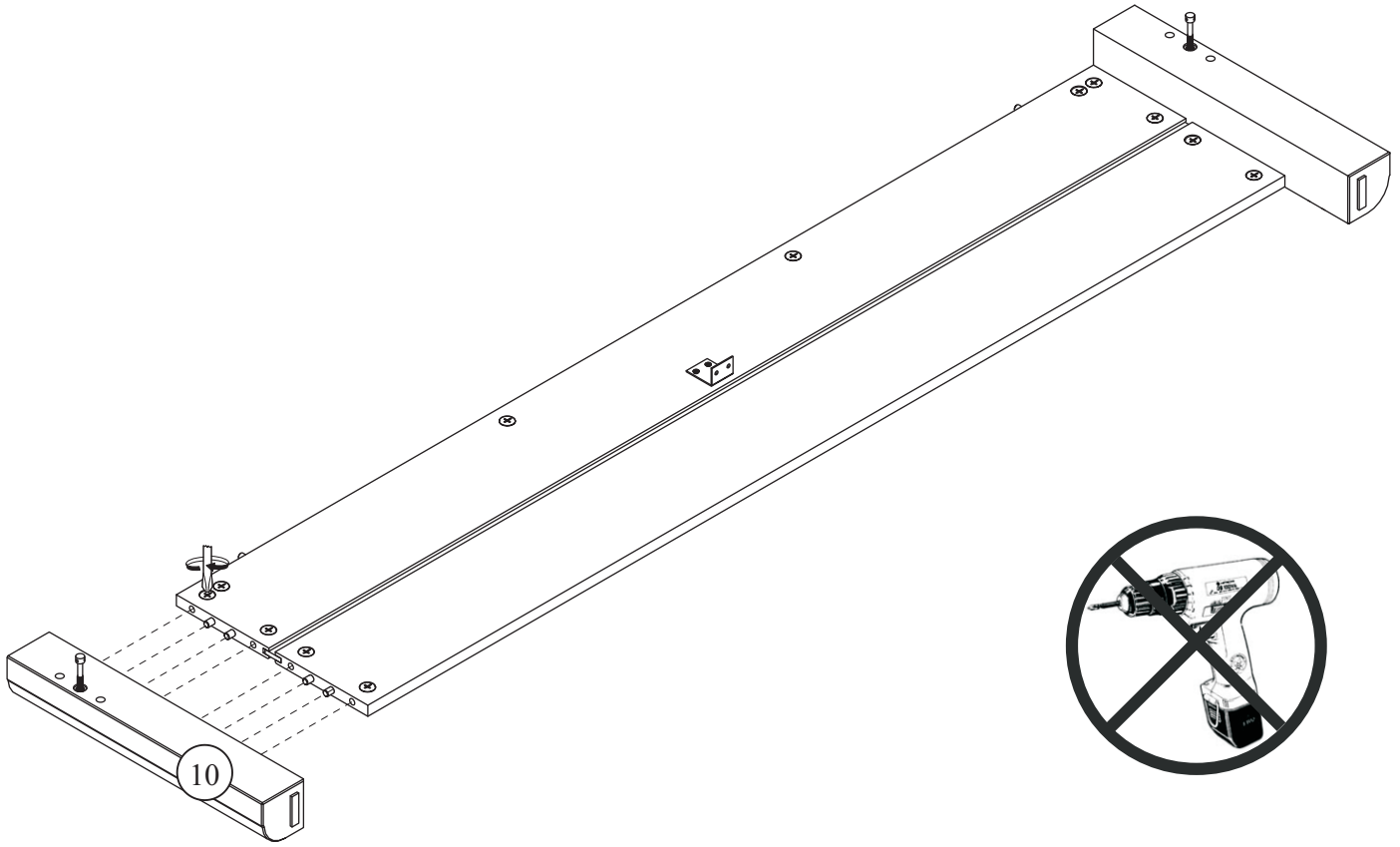

13

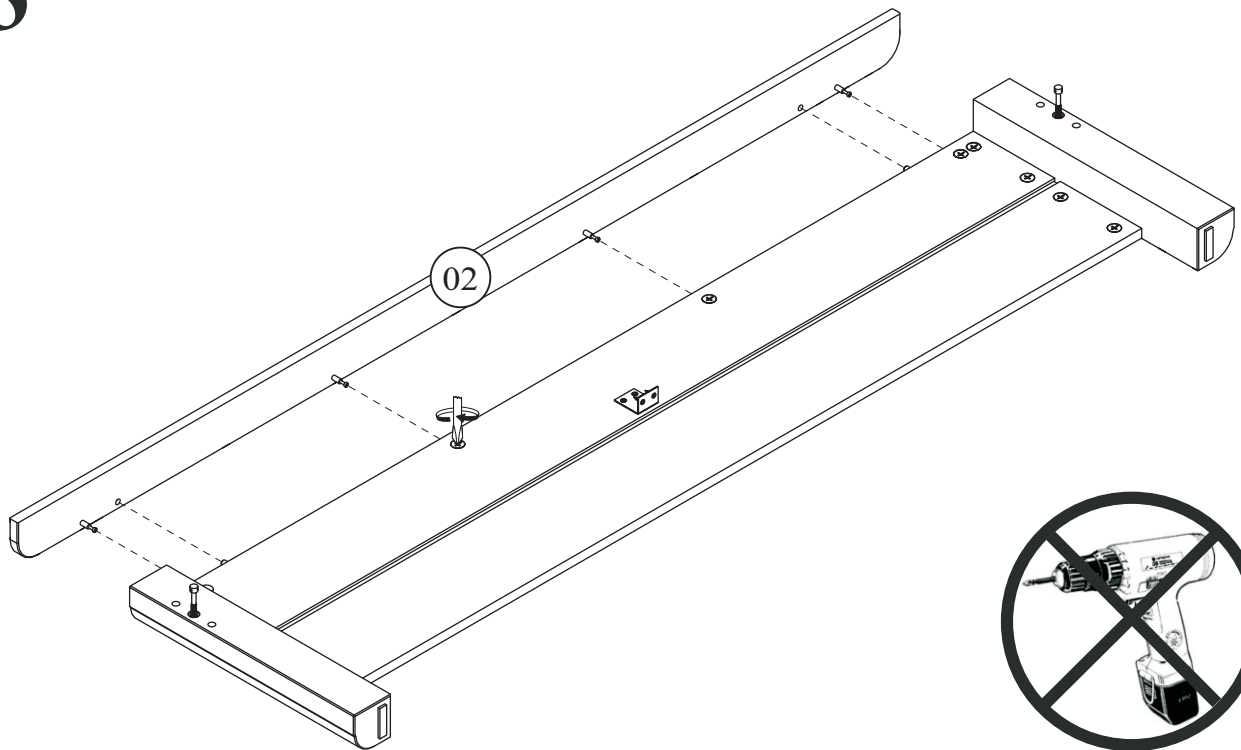

14

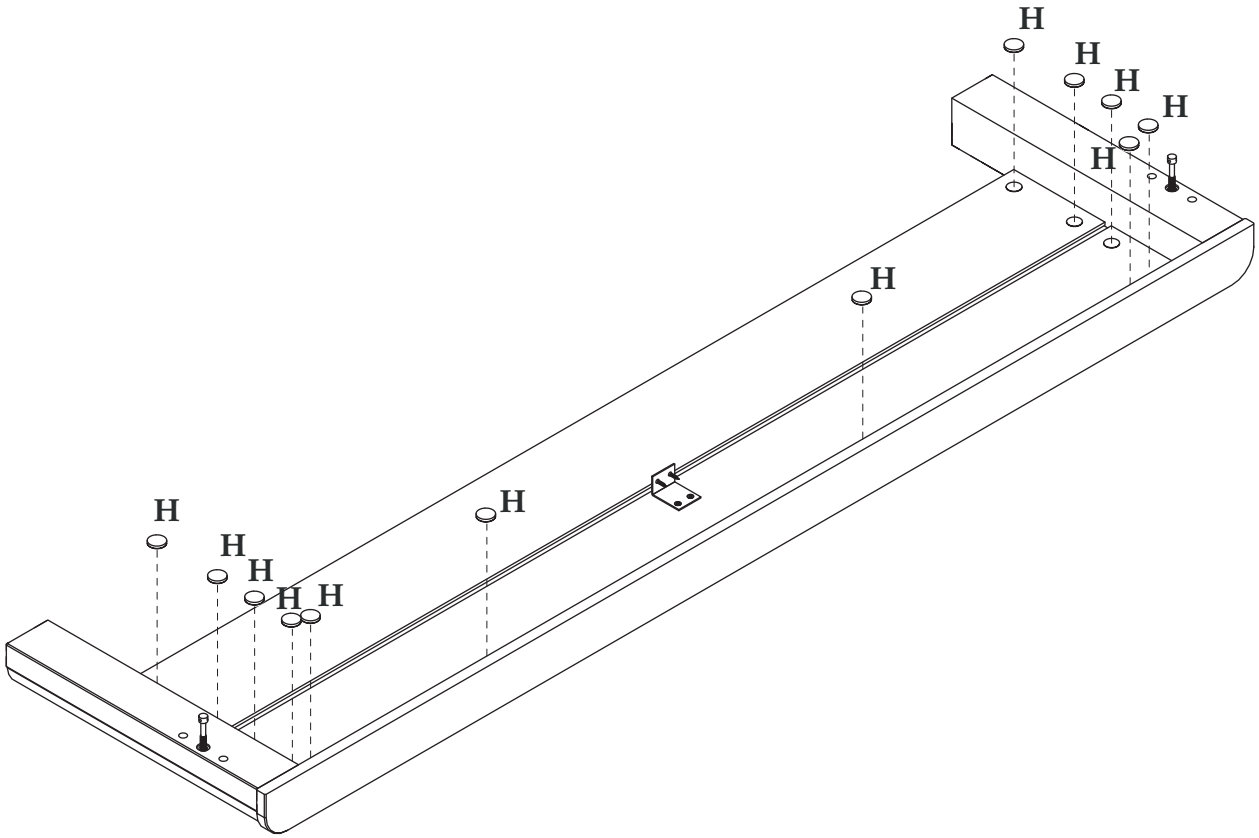

15

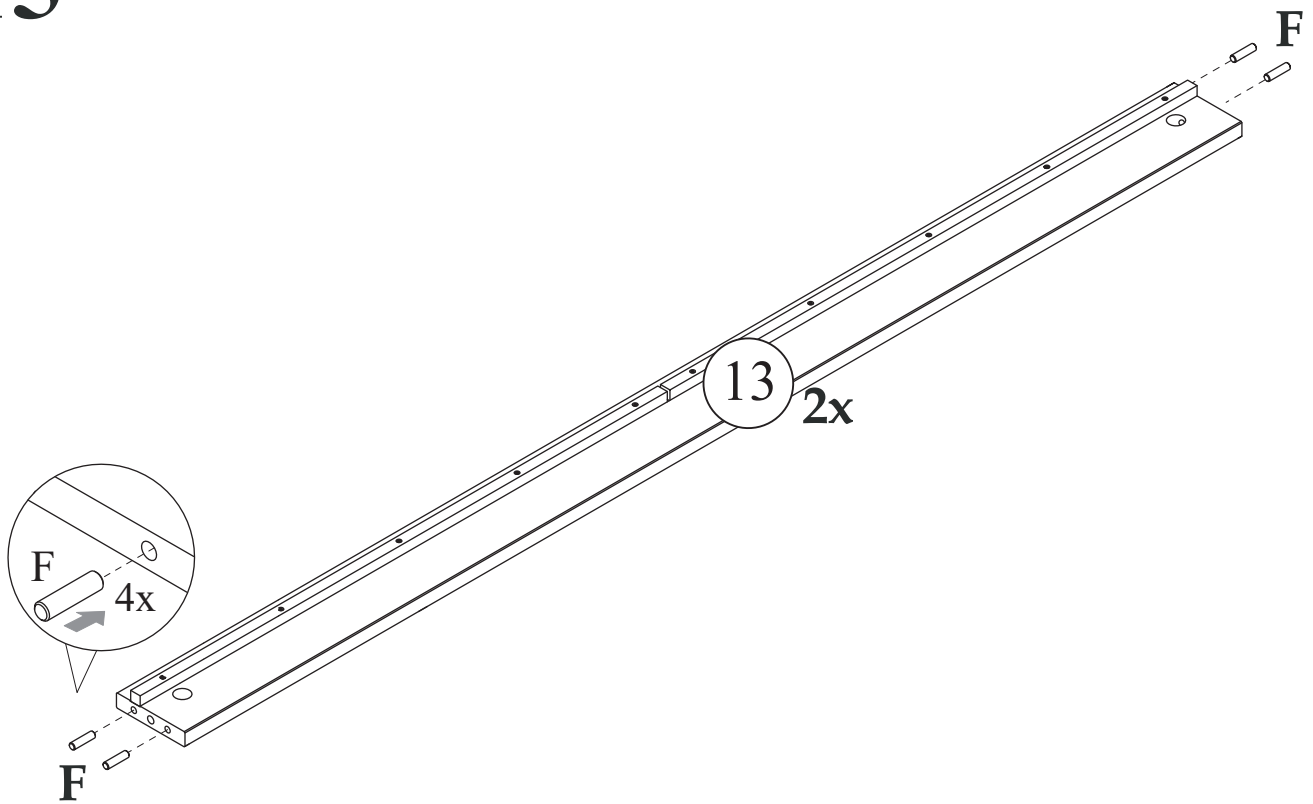

16

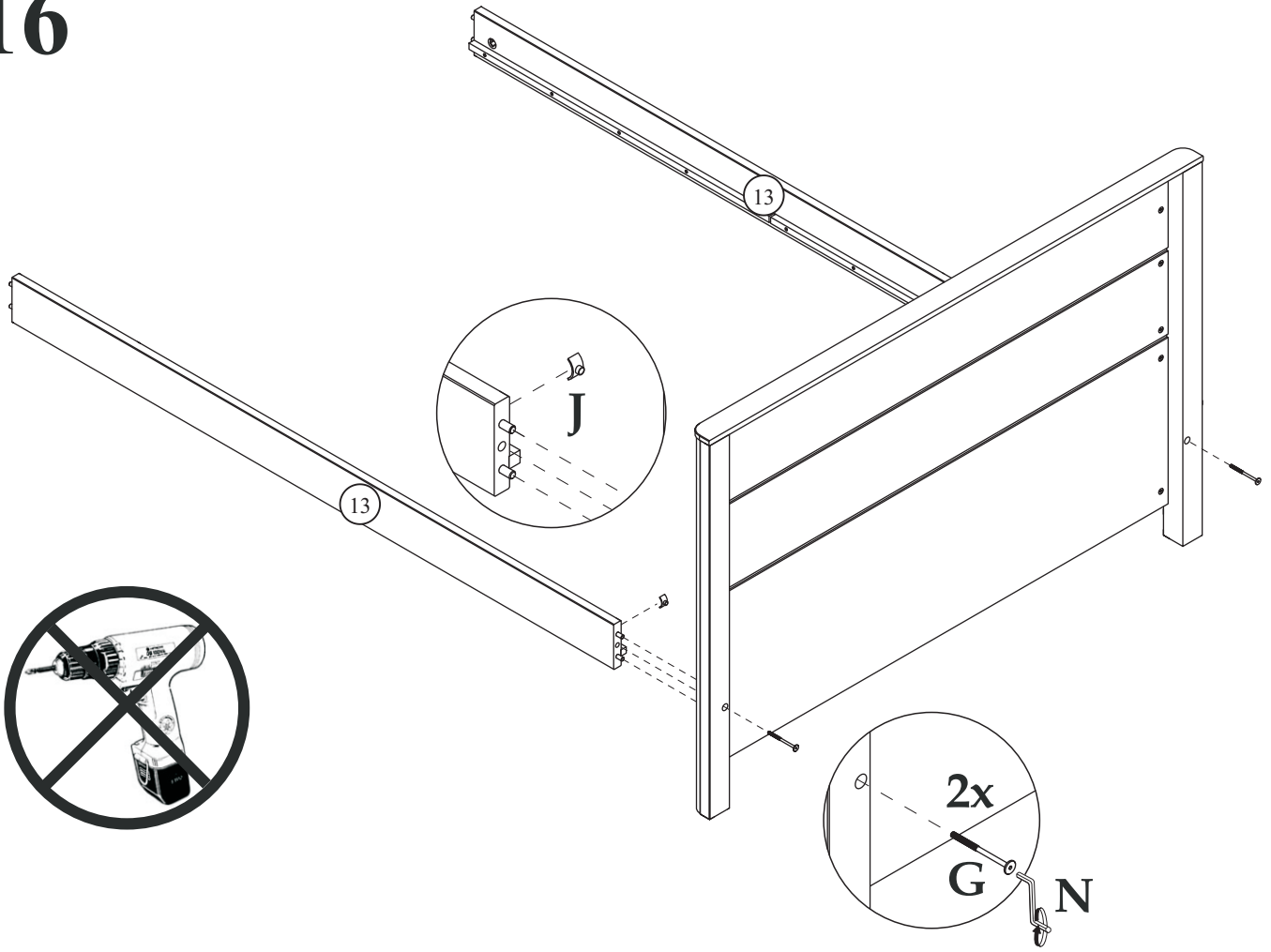

17

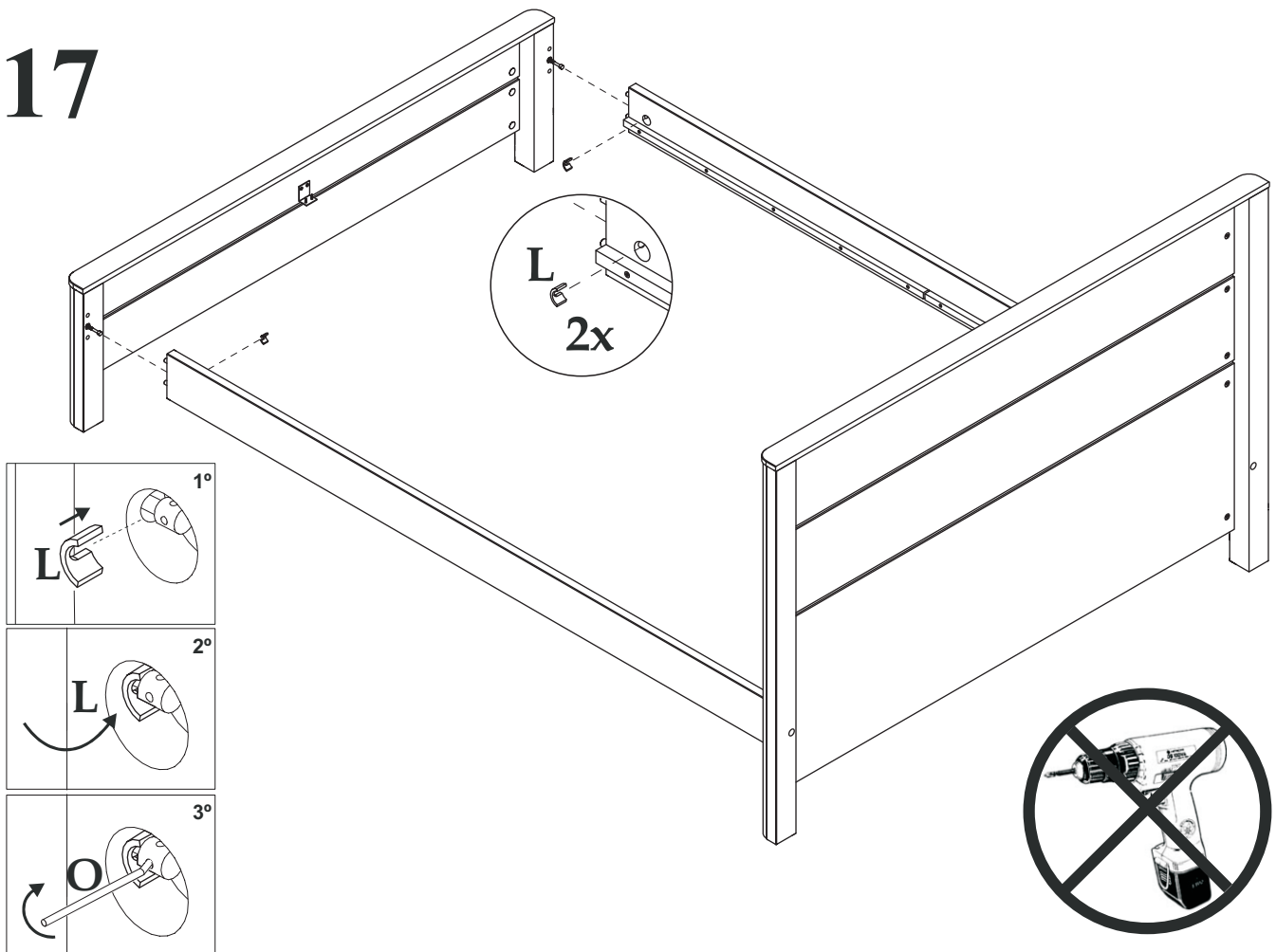

18

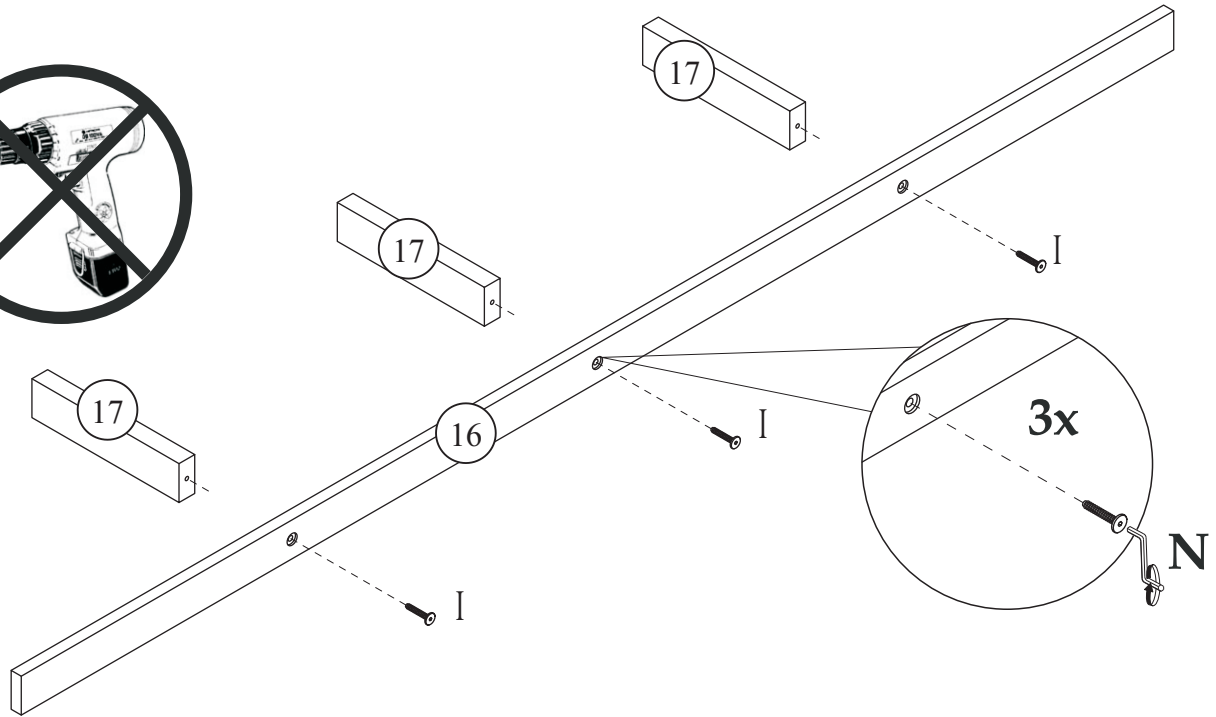

19

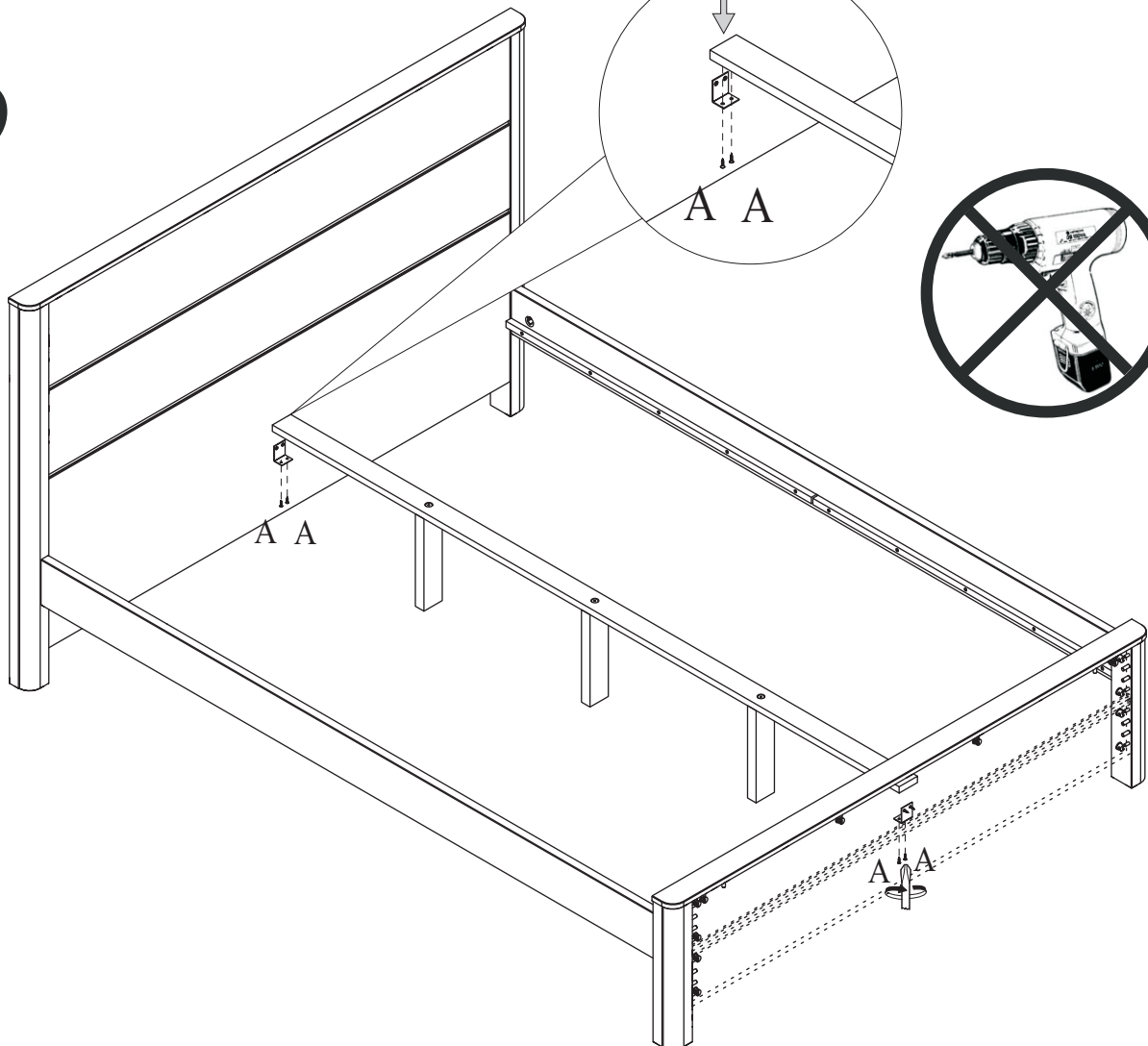
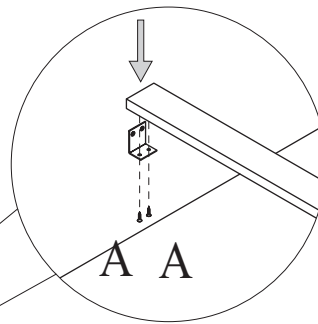

20

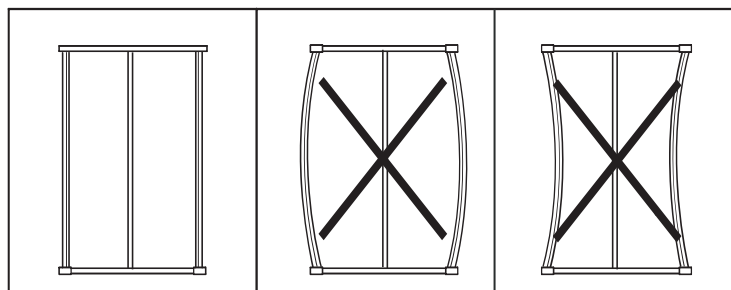
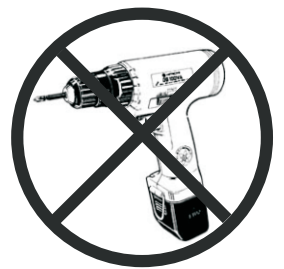
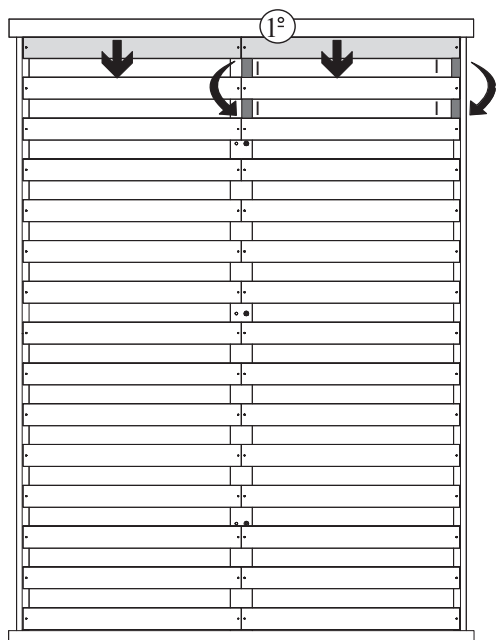
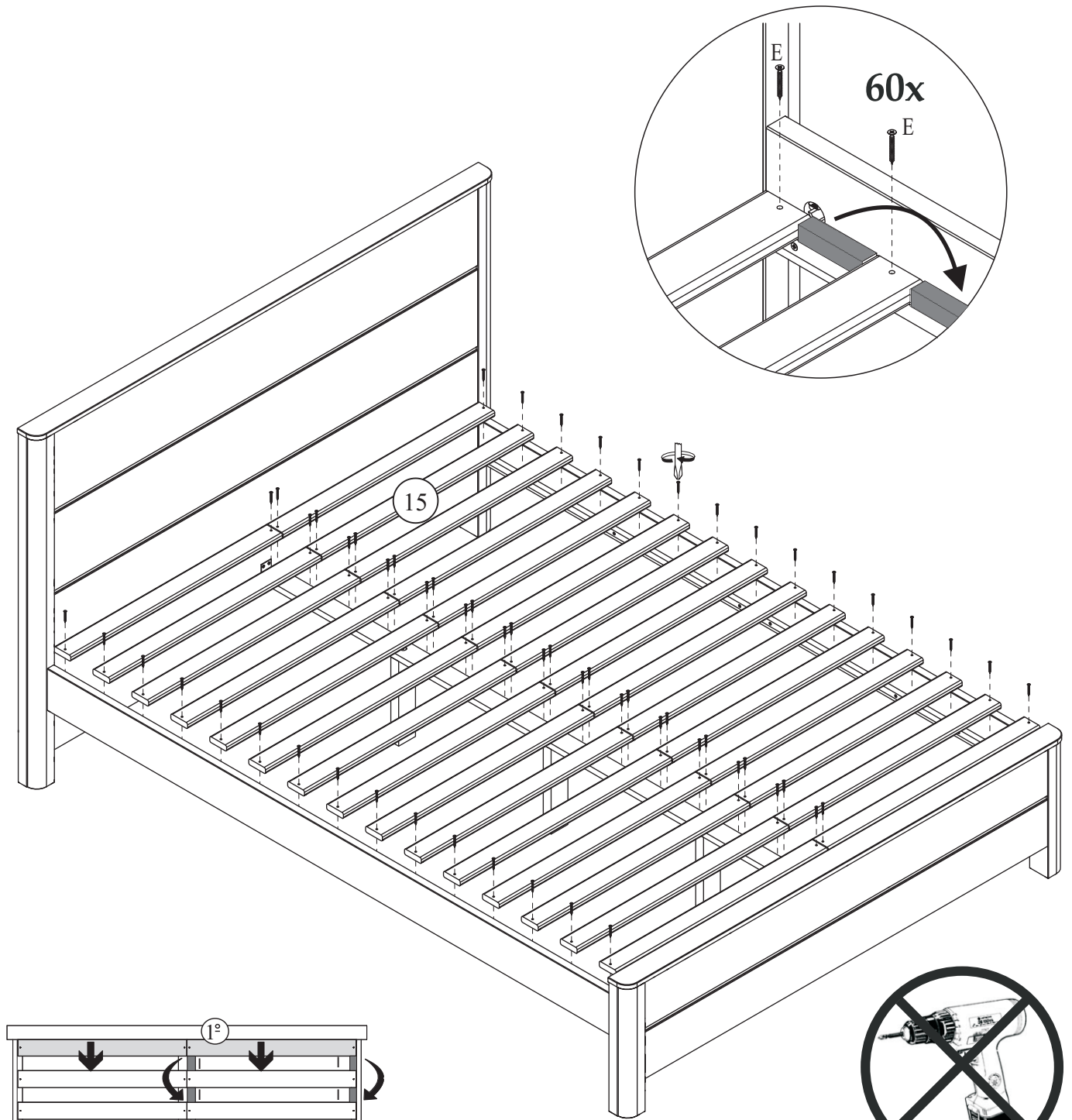

General Care

Wipe clean with a slightly damp soft cloth.

Avoid the use of all household cleaners and abrasives.

When moving your furniture, carefully lift into place.

Never drag or push the pieces across the floor as this will cause damage to the joints and could result in failure to the product that will invalidate the warranty.

Recommendations

Periodical re-tightening of fixings.

Warnings

This unit is heavy. Please use an assistant when lifting.

Notes

We've tried to make this piece of furniture as easy to assemble as possible.

In the unlikely event that you have problems putting it together or have damaged or missing pieces, please contact our customer services on 01623 727374